

60 GU-36 1F  
60 GUS-36 1F

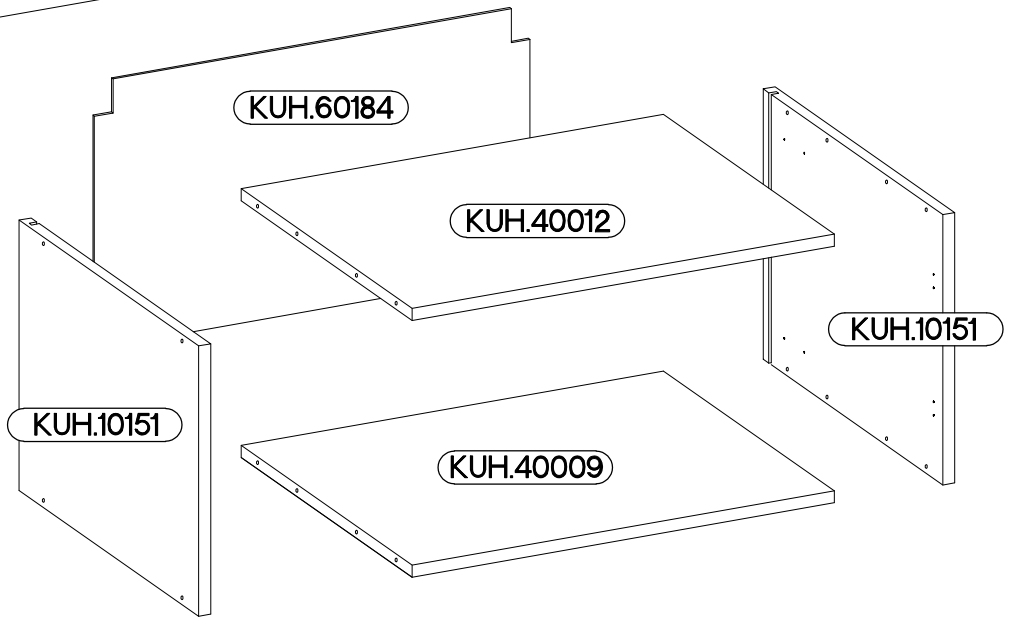

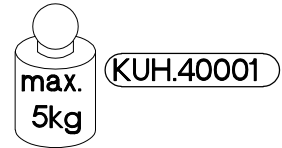
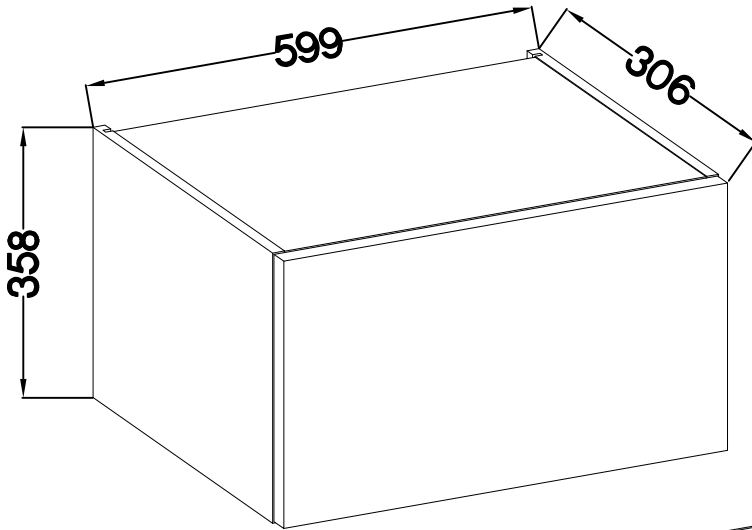
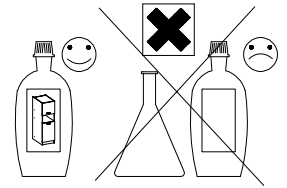
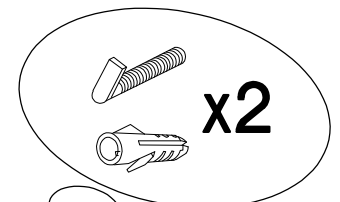

Ersatzteil Nummer	Dimension
KUH.10051 x2	357,5x290x16
KUH.40009	567x276x16
KUH.40012	567x276x16
KUH.60184	353x585x2,5

 A 8	 B 8	 E1 8	 HG 2	 K 2
 K24 2	 O 1	 P5 4	 P7 8-10	 P8 4



ISM-KUH-01627

# 1

$\pm 8 \times 30 \text{mm}$ 	$\pm 4.0 \times 30 \text{mm}$ 	
A	P8	K
8	4	2

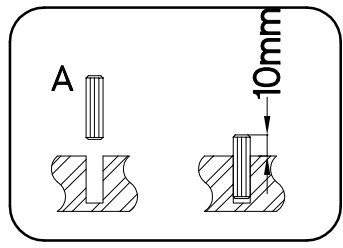
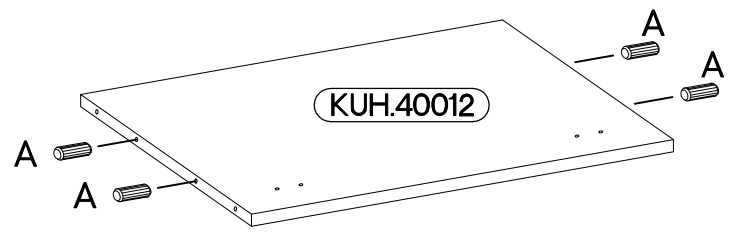
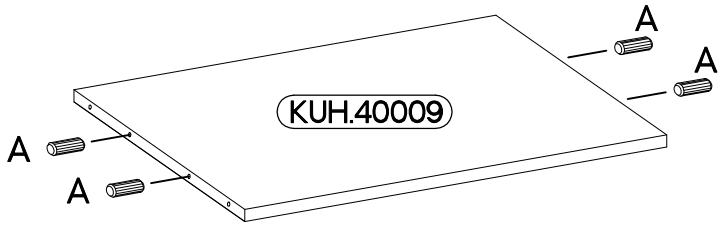
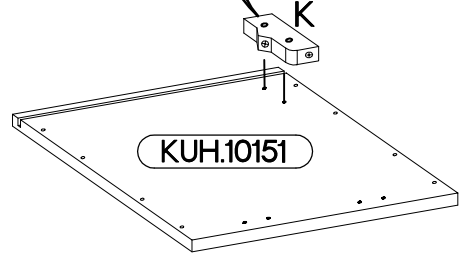
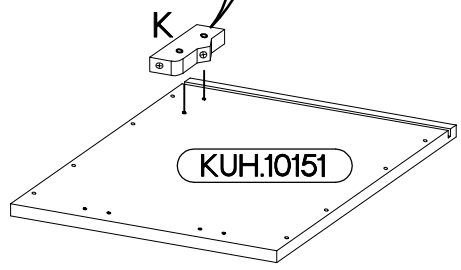
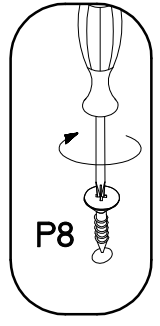
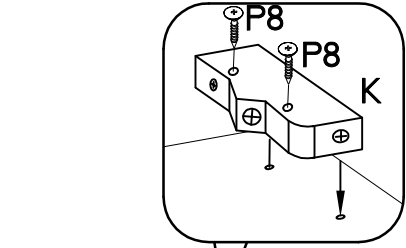
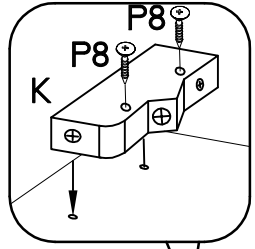
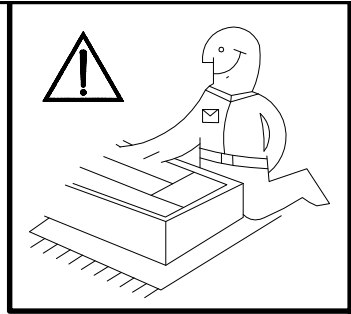

# 2

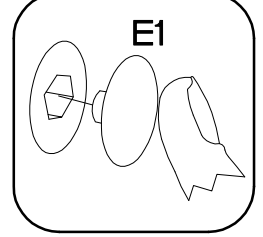
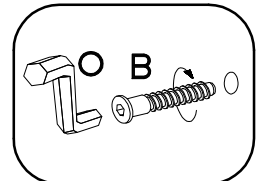
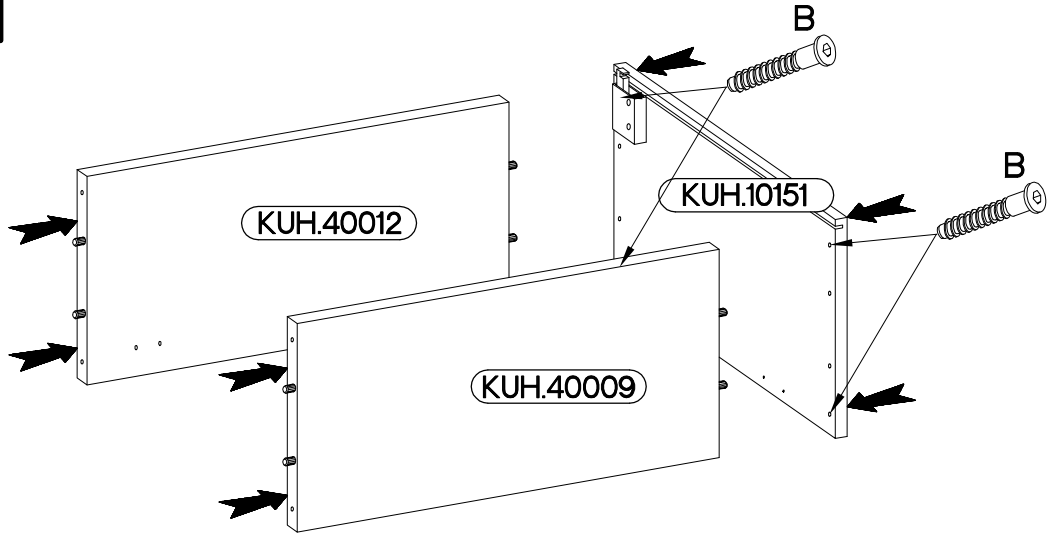

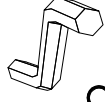
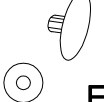
$6,4 \times 50 \text{mm}$ 		
B	O	E1
4	1	4

3

6,4 x 50mm

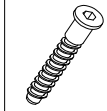

B

4

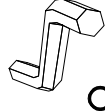

O

1

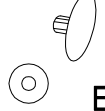

E1

4

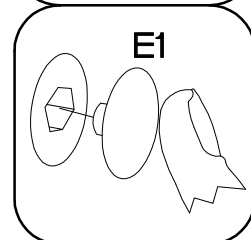
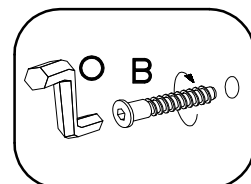
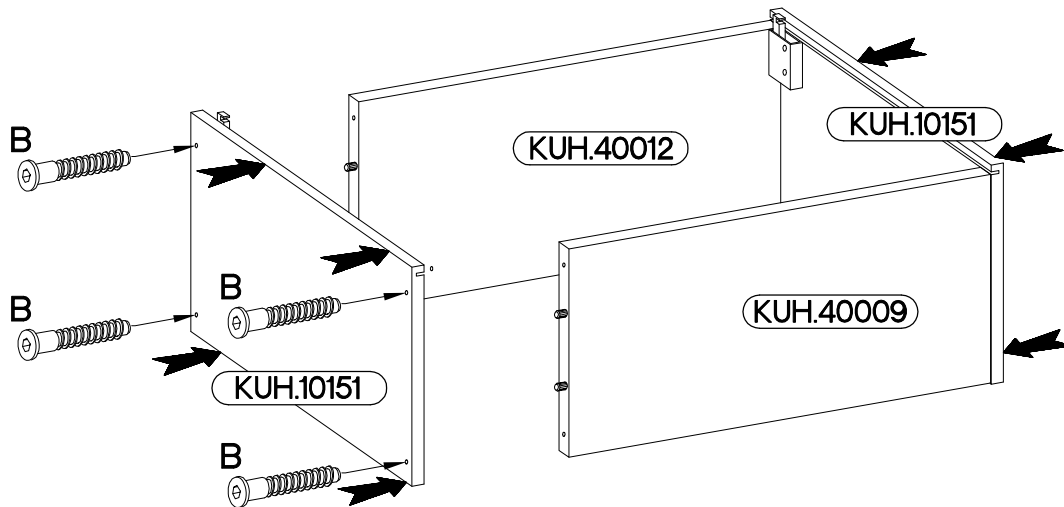
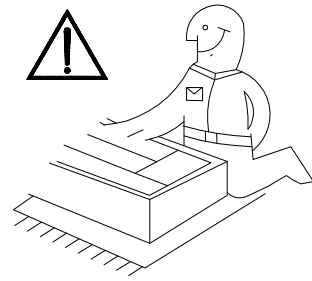

4

±3.0x20mm



P7

8-10

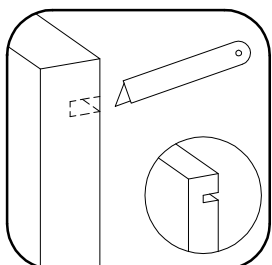
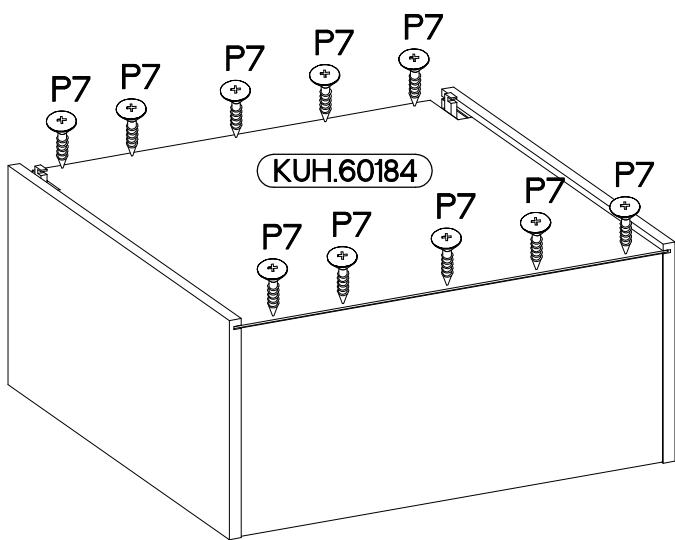
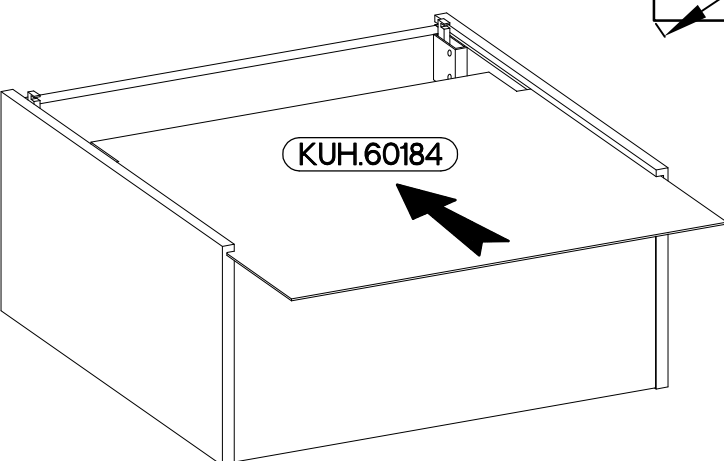
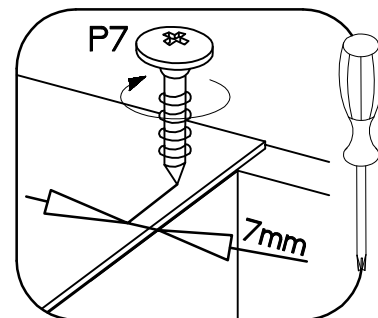
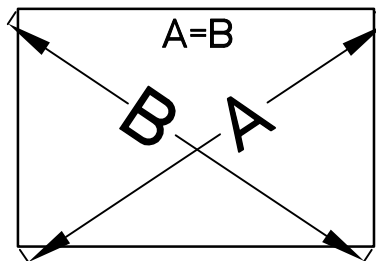

5

FRONT

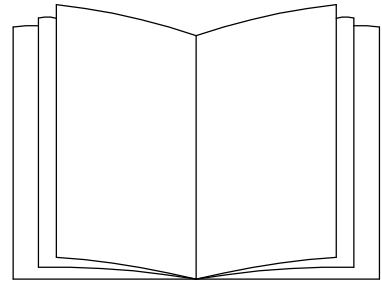
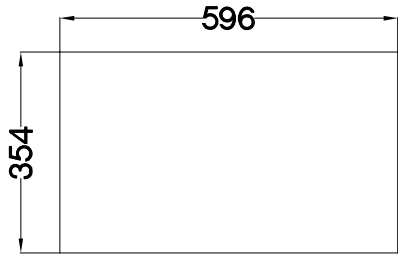

6

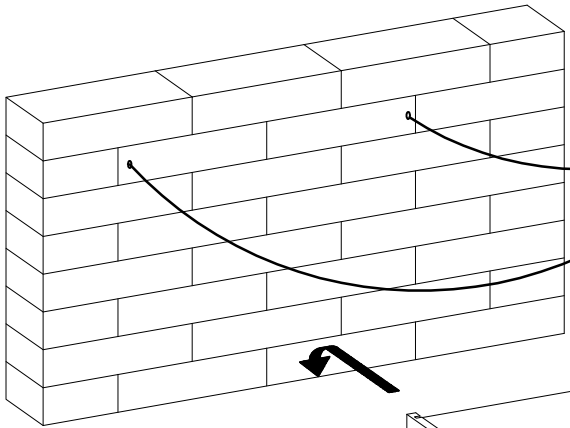

A

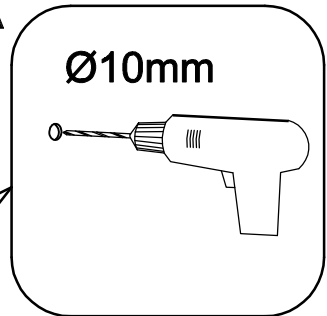

B

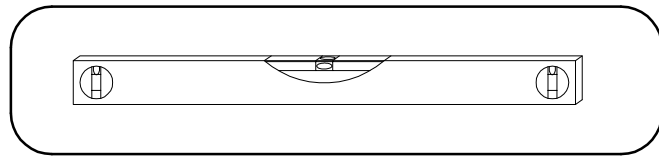
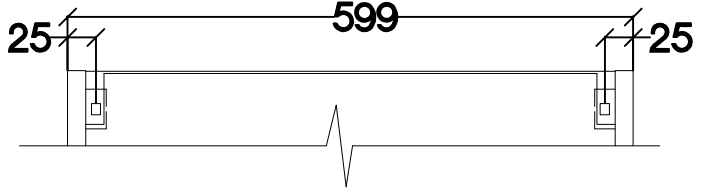
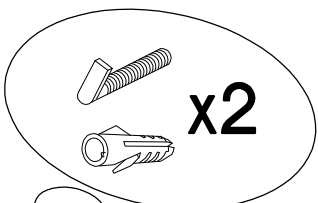
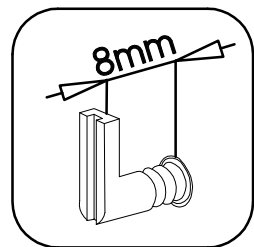
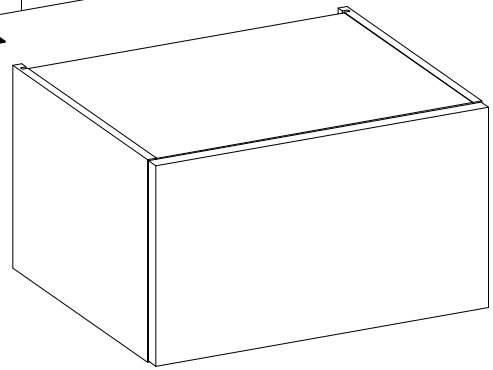
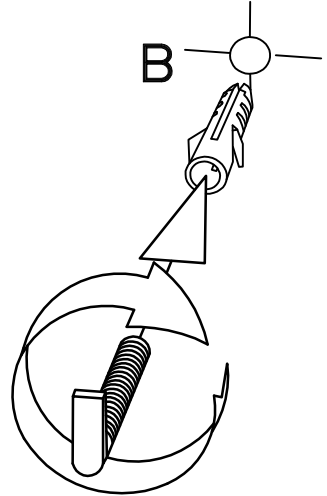

C

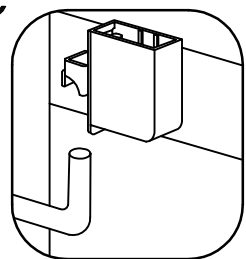

D

